

Mini HiFi System

FW930R



Toll Free Help Line

Ligne d'assistance en service libre
Linea de ayuda telefónica sin cargo

800-531-0039



Let's make things better.



PHILIPS

Return your Warranty Registration card today to ensure you receive all the benefits you're entitled to.

- Once your Philips purchase is registered, you're eligible to receive all the privileges of owning a Philips product.
- So complete and return the Warranty Registration Card enclosed with your purchase at once. And take advantage of these important benefits.

Warranty Verification

Registering your product within 10 days confirms your right to maximum protection under the terms and conditions of your Philips warranty.

Owner Confirmation

Your completed Warranty Registration Card serves as verification of ownership in the event of product theft or loss.

Model Registration

Returning your Warranty Registration Card right away guarantees you'll receive all the information and special offers which you qualify for as the owner of your model.

Know these
safety symbols



For Customer Use

Enter below the Serial No. which is located on the rear of the cabinet. Retain this information for future reference.

Model No. _____

Serial No. _____



This “bolt of lightning” indicates uninsulated material within your unit may cause an electrical shock. For the safety of everyone in your household, please do not remove product covering.



The “exclamation point” calls attention to features for which you should read the enclosed literature closely to prevent operating and maintenance problems.

WARNING: TO PREVENT FIRE OR SHOCK HAZARD, DO NOT EXPOSE THIS EQUIPMENT TO RAIN OR MOISTURE.

CAUTION: To prevent electric shock, match wide blade of plug to wide slot, and fully insert.

PHILIPS

***Congratulations on your purchase,
and welcome to the “family!”***

Dear Philips product owner:

Thank you for your confidence in Philips. You've selected one of the best-built, best-backed products available today. And we'll do everything in our power to keep you happy with your purchase for many years to come.

As a member of the Philips “family,” you're entitled to protection by one of the most comprehensive warranties and outstanding service networks in the industry.

What's more, your purchase guarantees you'll receive all the information and special offers for which you qualify, plus easy access to accessories from our convenient home shopping network.



And most importantly you can count on our uncompromising commitment to your total satisfaction.

All of this is our way of saying welcome—and thanks for investing in a Philips product.

Sincerely,

Robert Minkhorst
President and Chief Executive Officer

P.S. Remember, to get the most from your Philips product, you must return your Warranty Registration Card within 10 days. So please mail it to us right now!

	CAUTION RISK OF ELECTRIC SHOCK DO NOT OPEN	
<p>CAUTION: TO REDUCE THE RISK OF ELECTRIC SHOCK, DO NOT REMOVE COVER (OR BACK). NO USER-SERVICEABLE PARTS INSIDE. REFER SERVICING TO QUALIFIED SERVICE PERSONNEL.</p>		



This symbol warns the user that uninsulated voltage within the unit may have sufficient magnitude to cause electric shock. Therefore, it is dangerous to make any kind of contact with any inside part of this unit.



This symbol alerts the user that important literature concerning the operation and maintenance of this unit has been included. Therefore, it should be read carefully in order to avoid any problems.

WARNING

To reduce the risk of fire or electric shock, do not expose this appliance to rain or moisture.

CAUTION

Use of controls or adjustments or performance of procedures other than herein may result in hazardous radiation exposure.

The set complies with the FCC-Rules, Part 15 and with 21 CFR 1040.10.

Canada

This digital apparatus does not exceed the Class B limits for radio noise emissions from digital apparatus as set out in the Radio Interference Regulations of the Canadian Department of Communications.

	AVIS RISQUE DE CHOCS ÉLECTRIQUES NE PAS OUVRIR	
<p>Attention: Afin de prévenir le risque de chocs électriques, ne pas retirer les vis. Toute réparation devrait être confiée à un personnel qualifié.</p>		



Ce symbole indique la présence d'une tension suffisamment élevée pour engendrer un risque de chocs électriques.



Ce symbole indique que le manuel d'installation fourni avec l'appareil contient d'importantes recommandations quant au fonctionnement et à l'entretien de ce dernier.

AVIS

Afin de réduire tout risque d'incendie ou de choc électrique, il ne faut pas exposer cet appareil à la pluie ou à l'humidité.

ATTENTION

L'utilisation des commandes ou réglages ou le non-respect des procédures ci-incluses peuvent se traduire par une exposition dangereuse à l'irradiation.

L'appareil répond aux normes FCC, Part 15 et 21 CFR 1040.10.

Canada

Cet appareil numérique n'émet pas de bruits radioélectriques dépassant les limites applicables aux appareils numériques de Class B prescrites dans le Règlement sur le Brouillage Radioélectrique édicté par le Ministère des Communications du Canada.

	AVISO RIESGO DE CHOQUE ELÉCTRICO NO ABRIR	
<p>Atención: Para reducir el riesgo de choque eléctrico, no quite la tapa (o el panel posterior). En su interior no hay piezas que el usuario pueda reparar. Para servicio dirijase a personal calificado.</p>		



Este símbolo tiene por finalidad advertir al usuario de la presencia de tensión peligrosa no aislada dentro de la caja del aparato, que puede ser lo suficientemente fuerte para constituir un peligro de choque eléctrico.



Este símbolo sirve para advertir al usuario de la presencia de instrucciones de manejo y mantenimiento (servicio) importantes en el manual que acompaña al aparato.

AVISO

Para reducir el riesgo de fuego o choque eléctrico, no exponga el aparato a la lluvia o humedad.



ATENCIÓN

El uso de mando o ajustes o la ejecución de métodos que no sean los aquí descritos puede ocasionar peligro de exposición a radiación.

El aparato cumple las normas FCC, Parte 15 y 21 CFR 1040.10.

This product was designed and manufactured to meet strict quality and safety standards. There are, however, some installation and operation precautions which you should be particularly aware of.

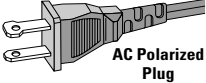
1. **Read these instructions** – All the safety and operating instructions should be read before the appliance is operated.
2. **Keep these instructions** – The safety and operating instructions should be retained for future reference.
3. **Heed all warnings** – All warnings on the appliance and in the operating instructions should be adhered to.
4. **Follow all instructions** – All operating and use instructions should be followed.
5. **Do not use this apparatus near water** – for example, near a bathtub, washbowl, kitchen sink, laundry tub, in a wet basement or near a swimming pool, etc.
6. **Clean only with a damp cloth.** The appliance should be cleaned only as recommended by the manufacturer.
7. **Install in accordance with the manufacturers instructions. Do not block any of the ventilation openings.** For example, the appliance should not be situated on a bed, sofa, rug, or similar surface or placed in a built-in installation, such as a bookcase or cabinet that may impede the flow of air through the ventilation openings.
8. **Do not install near any heat sources** such as radiators, heat registers, stoves, or other apparatus (including amplifiers) that produce heat.

9. **Do not defeat the safety purpose** of the polarized or grounding-type plug. A polarized plug has two blades with one wider than the other. A grounding type plug has two blades and a third grounding prong. The wide blade or the third prong are provided for your safety. When the provided plug does not fit into your outlet, consult an electrician for replacement of the obsolete outlet.
 
10. **Protect the power cord** from being walked on or pinched particularly at plugs, convenience receptacles, and the point where they exit from the apparatus.
11. **Only use attachments/accessories** specified by the manufacturer.
12.  **Use only with a cart, stand, tripod, bracket, or table** specified by the manufacturer, or sold with the apparatus. When a cart is used, use caution when moving the cart/apparatus combination to avoid injury from tip-over.
13. **Unplug this apparatus** during lightning storms or when unused for long periods of time.
14. **Refer all servicing** to qualified service personnel. Servicing is required when the apparatus has been damaged in any way, such as power-supply cord or plug is damaged, liquid has been spilled or objects have fallen into the apparatus, the apparatus has been exposed to rain or moisture, does not operate normally, or has been dropped.

English	6
Français	36
Español	70

English

Français

Español

EL 4562-E004: 99/3



LIMITED WARRANTY

AUDIO SYSTEM

One Year Free Labor

One Year Free Service on Parts

This product must be carried in for repair.

WHO IS COVERED?

You must have proof of purchase to receive warranty service. A sales receipt or other document showing that you purchased the product is considered proof of purchase.

WHAT IS COVERED?

Warranty coverage begins the day you buy your product. For one year thereafter, all parts will be repaired or replaced, and labor is free. After one year from the day of purchase, you pay for the replacement or repair of all parts, and for all labor charges.

All parts, including repaired and replaced parts, are covered only for the original warranty period. When the warranty on the product expires, the warranty on all replaced and repaired parts also expires.

WHAT IS EXCLUDED?

Your warranty does not cover:

- labor charges for installation or setup of the product, adjustment of customer controls on the product, and installation or repair of antenna systems outside of the product.
- product repair and/or part replacement because of misuse, accident, unauthorized repair or other cause not within the control of Philips Consumer Electronics Company.
- reception problems caused by signal conditions or cable or antenna systems outside the unit.
- a product that requires modification or adaptation to enable it to operate in any country other than the country for which it was designed, manufactured, approved and/or authorized, or repair of products damaged by these modifications.
- incidental or consequential damages resulting from the product. (Some states do not allow the exclusion of incidental or consequential damages, so the above exclusion may not apply to you. This includes, but is not limited to, prerecorded material, whether copyrighted or not copyrighted.)

- a product that is used for commercial or institutional purposes.

WHERE IS SERVICE AVAILABLE?

Warranty service is available in all countries where the product is officially distributed by Philips Consumer Electronics Company. In countries where Philips Consumer Electronics Company does not distribute the product, the local Philips service organization will attempt to provide service (although there may be a delay if the appropriate spare parts and technical manual(s) are not readily available).

MAKE SURE YOU KEEP..

Please keep your sales receipt or other document showing proof of purchase. Attach it to this owner's manual and keep both nearby. Also keep the original box and packing material in case you need to return your product.

BEFORE REQUESTING SERVICE...

Please check your owner's manual before requesting service. Adjustments of the controls discussed there may save you a service call.

TO GET WARRANTY SERVICE IN U.S.A., PUERTO RICO OR U.S. VIRGIN ISLANDS...

Take the product to a Philips factory service center (see enclosed list) or authorized service center for repair. When the product has been repaired, you must pick up the unit at the center. Centers may keep defective parts. (In U.S.A., Puerto Rico and U.S. Virgin Islands, all implied warranties, including implied warranties of merchantability and fitness for a particular purpose, are limited in duration to the duration of this express warranty. But, because some states do not allow limitations on how long an implied warranty may last, this limitation may not apply to you.)

TO GET WARRANTY SERVICE IN CANADA...

Please contact Philips at:

1-800-661-6162 (French Speaking)

1-800-363-7278 (English Speaking)

(In Canada, this warranty is given in lieu of all other warranties. No other warranties are expressed or implied, including any implied warranties of merchantability or fitness for a particular purpose. Philips is not liable under any circumstances for any direct, indirect, special, incidental or consequential damages, howsoever incurred, even if notified of the possibility of such damages.)

REMEMBER...

Please record the model and serial numbers found on the product below. Also, please fill out and mail your warranty registration card promptly. It will be easier for us to notify you if necessary.

MODEL # _____

SERIAL # _____

This warranty gives you specific legal rights. You may have other rights which vary from state/province to state/province.

**Philips Service Solutions Group, P.O. Box 2976,
Longview, Texas 75606, USA, (903) 242-4800**

<i>General Information</i>	7
<i>Safety Information</i>	7
<i>Preparation</i>	8 - 9
<i>Controls</i>	10 - 12
<i>Operating the system</i>	13 - 15
<i>CD</i>	15 - 17
<i>CD Recorder</i>	18 - 24
<i>Tuner</i>	25
<i>Tape</i>	26
<i>AUX/CDR</i>	27
<i>Recording</i>	27 - 28
<i>Clock</i>	29
<i>Timer</i>	29 - 30
<i>Maintenance</i>	30
<i>Specifications</i>	31
<i>Troubleshooting</i>	32 - 33

General Information

- **The typeplate (which contains the serial number) is located at the rear of the system.**
- **Recording is permissible if copyright or other rights of third parties are not infringed.**
- **This device complies with the Federal Communications Commission (FCC) rules, part 15 and with 21 CFR 1040.10. Operation is subjected to the following two conditions:**
 - **This device may not cause harmful interference, and**
 - **This device must accept any interference received, including interference that may cause undesired operation.**

Environmental Information

All unnecessary packaging has been omitted. We have tried to make the packaging easy to separate into three materials: cardboard (box), polystyrene foam (buffer) and polyethylene (bags, protective foam sheet).

Your system consists of materials which can be recycled and reused if disassembled by a specialized company. Please observe the local regulations regarding the disposal of packaging materials, exhausted batteries and old equipment.

Accessories (Supplied)

- Remote control
- Batteries (two AA size) for remote control
- AM loop antenna
- FM wire antenna
- AC power cord
- CD Recorder

Safety Information

- Before operating the system, check that the operating voltage indicated on the typeplate (or the voltage indication beside the voltage selector) of your system is identical with the voltage of your local power supply. If not, please consult your dealer. The typeplate is located at the rear of your system.
- When the system is switched on, do not move it around.
- Place the system on a solid base (e.g. a cabinet).
- Place the system in a location with adequate ventilation to prevent internal heat build-up in your system.
- The system incorporates a built-in safety feature that prevents over heating.
- Do not expose the system to excessive moisture, rain, sand or heat sources.
- Under no circumstances should you repair the system yourself, as this will invalidate the warranty!

- If the system is brought directly from a cold to a warm location, or is placed in a very damp room, moisture may condense on the lens of the CD unit inside the system. Should this occur, the CD player will not operate normally. Leave the power on for about one hour with no disc in the system until normal playback is possible.
- Electrostatic discharge may cause unexpected problems. See whether these problems disappear if you unplug the AC power cord and plug it in again after a few seconds.
- **To disconnect the system from the power supply completely, remove the AC power plug from the wall socket.**

Rear Connections

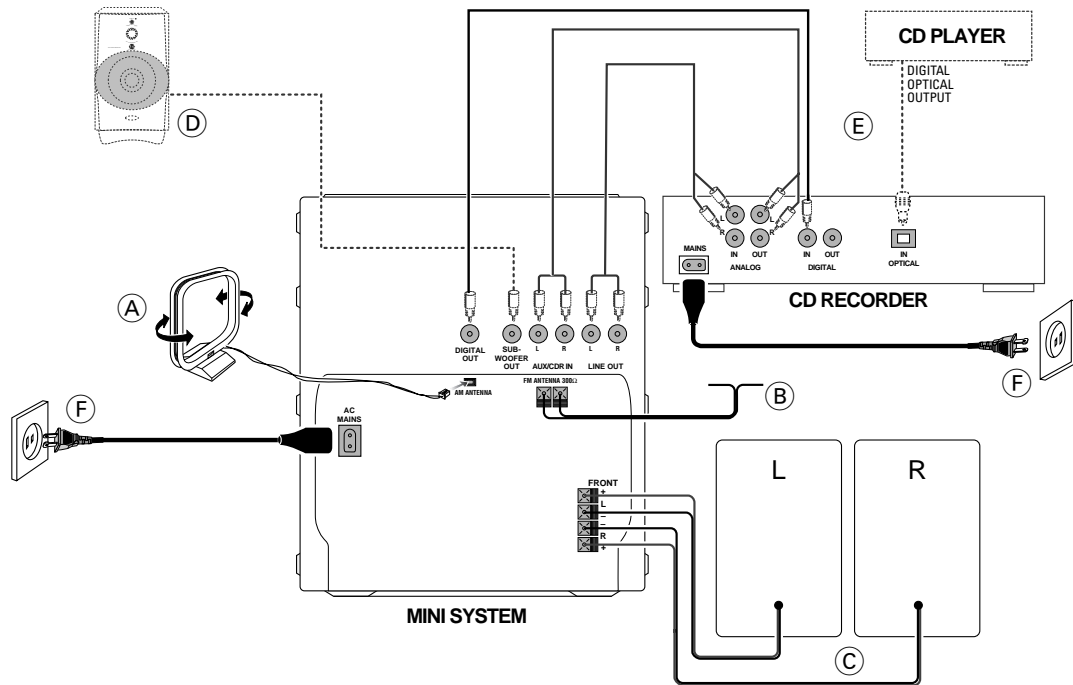

Connections general

The connections you make will depend upon the possibilities your audio equipment offers. Please refer to the user manuals for your other audio equipment first.

Digital recordings (optical or coaxial) give the best performance in audio and usability (e.g. auto-track). (The digital optical connection is less sensitive to external disturbances). If your equipment does not offer digital connections, the high quality Analog-Digital-Converter of your CD recorder will ensure very good audio performance when recordings are made from the analog input.

Playback via the digital coaxial output of the CD recorder gives the best audio performance. If your equipment does not offer digital connections, the high quality Digital-Analog-Converter of the CD recorder ensures a very good sound quality via the analog output.

We advise you to always establish both digital and analog connections. In this way you can always make analog recordings when digital recording is not possible.

(A) AM Loop Antenna Connection

Connect the supplied loop antenna to the AM ANTENNA terminal. Place the AM loop antenna far away from the system and adjust its position for the best reception.

(B) FM Wire Antenna Connection

Connect the supplied FM wire antenna to the FM ANTENNA 300 Ω terminal. Adjust the position of the FM antenna for the best reception.

Outdoor Antenna

For better FM stereo reception, connect an outdoor FM antenna to the FM ANTENNA 300 Ω terminal using a 300 Ω dipole wire.

(C) Speakers Connection

- Connect the right speaker to Front terminal R, with the colored wire to + and the black wire to —.
- Connect the left speaker to Front terminal L, with the colored wire to + and the black wire to —.
- Clip the stripped portion of the speaker wire as shown.

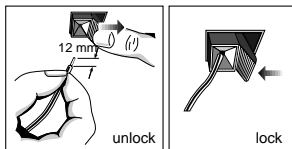

(D) Subwoofer Out Connection

Connect the optional active subwoofer to the SUBWOOFER OUT terminal. The subwoofer reproduces just the low bass effect (e.g. explosions, the rumble of spaceships, etc.). Be sure to follow the instructions supplied with the subwoofer.

(E) CD Recorder Connections

ANALOG CONNECTIONS

Connect the red plugs to the R sockets, and the white plugs to the L sockets.

For recording

Connect cable between the ANALOG IN-sockets on the CD recorder and the LINE OUT sockets on the mini system, or the CDR LINE- or TAPE OUT-sockets of an amplifier.

Note:

- For recording directly from a CD player, the analog input of the CD recorder should be connected to the analog output of the CD player.

For playback

Connect cable between the ANALOG OUT-sockets on the CD recorder and the AUX/CDR IN sockets on the mini system, or the input sockets of an amplifier e.g. TAPE IN, CDR or AUX.

Note:

- Never use the PHONO input.

DIGITAL COAXIAL CONNECTIONS

For recording

Connect the cable between the DIGITAL IN-socket on the CD recorder and the DIGITAL OUT-socket on the mini system or CD player.

For playback

Connect the cable between the DIGITAL OUT-socket on the CD recorder and the digital coaxial input of an amplifier or recording device.

Note:

- Digital coaxial connection is only required in case you wish to record from a CD player with digital coaxial output.

DIGITAL OPTICAL CONNECTIONS

For recording

Connect a fibre-optic cable (not supplied) between the IN OPTICAL of the CD recorder and the digital-optical output of a CD player.

Notes:

- Digital optical connection is only required in case you wish to record from a CD player with digital optical output.
- For playback, the digital coaxial output or analog output should be connected to an amplifier.
- When connecting the Digital Optical cable, make sure it is fully inserted until there is a click.

(F) AC Power Supply

After all other connections have been made, connect the AC power cord to the system and to the wall outlet.

Inserting batteries into the Remote Control

- Insert the batteries (Type R06 or AA) into the remote control as shown in the battery compartment.

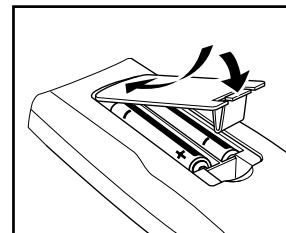

- To avoid damage from possible battery leakage, remove dead batteries or batteries that will not be used for a long time. For replacement, use type R06 or AA batteries.

CONTROLS

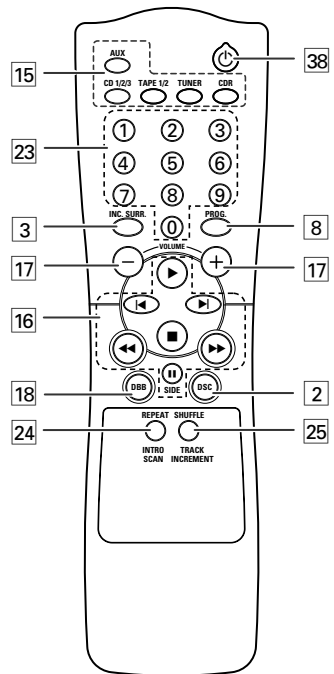
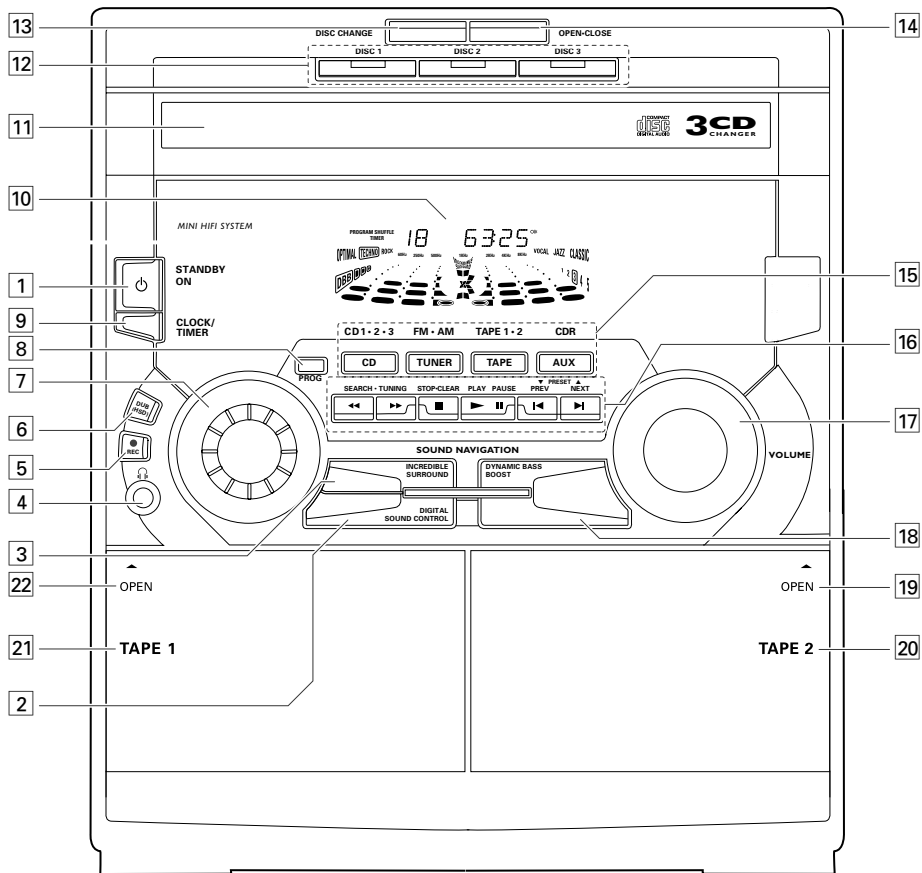

Controls on the system and remote control

1 STANDBY ON

- to switch the system on or to standby mode.
- to use for EASY SET.

2 DIGITAL SOUND CONTROL (DSC)

- to select the desired sound effect : OPTIMAL, CLASSIC, TECHNO, JAZZ, ROCK or VOCAL.

3 INCREDIBLE SURROUND

- to switch on or off the surround sound effect.

4 HEADPHONES

- to connect headphones.

5 REC (RECORD)

- to start recording on tape deck 2.
- **for CD Recorder**
- to start recording, finalizing and erasing.

6 DUB (HIGH SPEED DUBBING [HSD])

- to dub a tape in normal or fast speed.

7 JOG

- to select the desired equalizer display.
- to select the desired DSC setting. You must select the DSC feature first.
- to select the desired level of Incredible Surround Sound. You must select the Incredible Surround Sound feature first.

8 PROG (PROGRAM)

- to program CD tracks in CD mode or preset radio stations in tuner mode.

9 CLOCK/TIMER

- to view the clock, set the clock or set the timer.

10 DISPLAY SCREEN

- to view the current setting of the system.

11 CD CAROUSEL TRAY

12 CD DIRECT PLAY (DISC 1 / DISC 2 / DISC 3)

- to select a CD tray for playback.

13 DISC CHANGE

- to change CD(s).

14 OPEN•CLOSE

- to open or close the CD carousel.

for CD Recorder

- to open or close the disc tray.

15 SOURCE : to select the following:

CD / (CD 1•2•3)

- to select CD mode. When CD playback is stopped, press to select the disc tray 1, 2 or 3.

TUNER / (FM•AM)

- to select Tuner mode. When in Tuner mode, press to select the waveband: FM or AM.

TAPE / (TAPE 1•2)

- to select Tape mode. When tape playback is stopped, press to select either tape deck 1 or 2.

AUX / (CDR)

- to select sound from an external source (e.g. TV, VCR, Laser Disc player, DVD player or CD Recorder). When in Aux mode, press to select either AUX or CDR.

16 MODE SELECTION

SEARCH ◀◀ ▶▶ (TUNING ◀◀ ▶▶)

- for CD to search backward/forward.

- for TUNER to tune to a lower or higher radio frequency.

- for TAPE to rewind or fast forward a tape on tape deck 2 only.

- for CD Recorder...to search backward/forward.
- cursor control in Menu/Prog. review mode.

STOP•CLEAR ■

- DEMO (*on the system only*) to start or stop demonstration mode.

- for CD to stop CD playback or to clear a program.

- for TUNER to stop programming.

- for TAPE to stop playback or recording.

- for CD Recorder...to stop or clear a program.

PLAY ▶ / PAUSE II

- for CD to start or interrupt playback.

- for TAPE to start playback.

- for CD Recorder...to start playback/interrupt playback or recording.

PREV ◀ / NEXT ▶ (PRESET ▼ ▲)

- for CD to skip to the beginning of the current, previous, or next track.

- for TUNER to select a preset station in memory.

17 VOLUME

- to adjust the volume.

18 DYNAMIC BASS BOOST (DBB)

- to select a bass boost level or to switch off bass boost.

19 OPEN

- to open tape deck 2.

20 TAPE DECK 2

21 TAPE DECK 1

22 OPEN

- to open tape deck 1.

23 Digit 0 - 9

- (numbers consisting of two figures must be keyed in within 2 seconds).
- to key in a CD track (*only for CDR operation*).

24 REPEAT / INTRO SCAN

- to repeat a CD track, a disc, or all available discs.
- to play the first 10 seconds of each track (*only for CDR operation*).

25 SHUFFLE / TRACK INCREMENT

- to play all the available discs and their tracks in random order.
- to increase track numbers during recording (*only for CDR operation*).

26 ON/OFF (*on CD Recorder only*)

- to turn the CD recorder ON or OFF.

27 CD RECORDER DISC TRAY

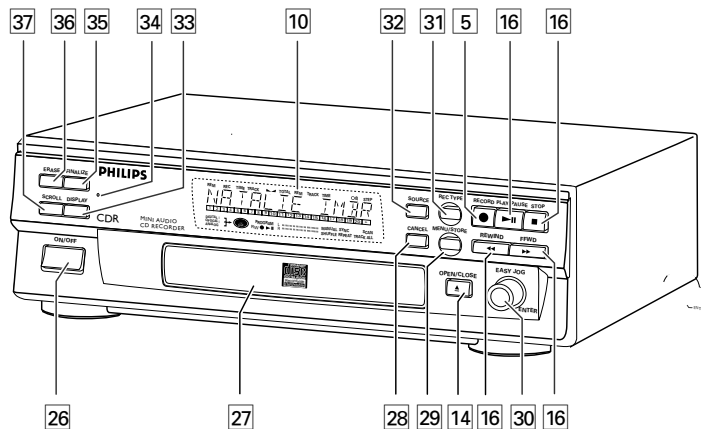

- 28 CANCEL** (on CD Recorder only)
 - to delete tracks from a program.
 - to delete text in Menu mode.
 - to return to a higher level in the menu.
- 29 MENU/STORE** (on CD Recorder only)
 - to select Menu mode.
 - to store Menu settings.
- 30 EASY JOG**-rotate (on CD Recorder only)
 - to skip to the previous/next track in Playback or Program mode.
 - to control recording level in Recording mode.
 - to select settings in Menu mode.

- ENTER**-push
 - to play the selected tracks.
 - to select settings in Menu mode.
 - to program track numbers.
- 31 REC TYPE** (on CD Recorder only)
 - to select recording mode.
- 32 SOURCE** (on CD Recorder only)
 - to select input source.
- 33 DISPLAY** (on CD Recorder only)
 - to select display information/text.
- 34 STANDBY INDICATOR** (on CD Recorder only)
- 35 FINALIZE** (on CD Recorder only)
 - to select finalize mode.

- 36 ERASE** (on CD Recorder only)
 - to select erasing mode.
- 37 SCROLL** (on CD Recorder only)
 - to activate scrolling of text over the display (once).
- 38** 
 - to switch the system to standby mode.

Notes for remote control:

- **First select the source you wish to control by pressing one of the source select keys on the remote control (e.g. CD 1/2/3, TAPE 1/2, TUNER, AUX or CDR).**
- **Then select the desired function (▶, ◀, ▶|, etc.).**

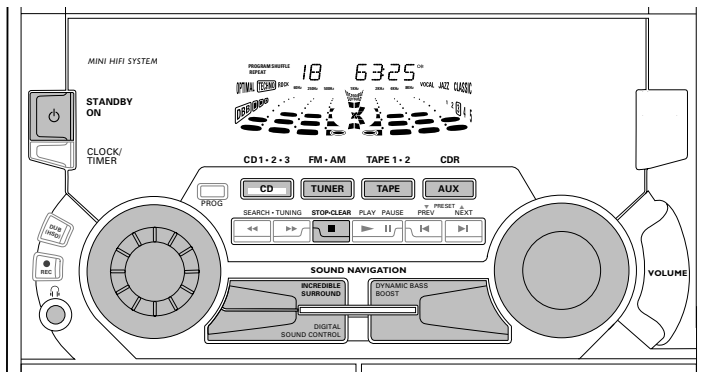

Important:
Before you operate the system, complete the preparation procedures.

Demonstration mode

The system has a demonstration mode that shows the various features offered by the system. **When the system is switched on for the first time, the demonstration mode will start automatically.**

Notes:

- During the demonstration, if you press any source (or standby-on) button, the system will switch to the respective mode (or standby).
- When the system is switched to standby mode, the demonstration will resume five seconds later.

To stop the demonstration mode

- Press and hold **STOP•CLEAR** ■ (on the system only) for **five seconds** when the system is in demonstration mode.
 - The demonstration will stop.
 - "DEMO OFF" is displayed.
 - The system will switch to standby mode.

Note:

- Even though the AC power cord is removed from and reconnected to the wall socket, the demonstration will remain off until it is switched on again.

To start the demonstration mode

- Press and hold **STOP•CLEAR** ■ (on the system only) for **five seconds** when the system is in standby mode.
 - The demonstration will begin.

Easy Set

EASY SET allows you to store all available radio stations automatically.

- 1 Press and hold **STANDBY ON** (on the system only) for **five seconds**; when the system is in standby or demonstration mode.
 - "EASY SET" will be displayed, and followed by "TUNER" and then "AUTO".
 - EASY SET will start searching for all radio on FM band and then followed by radio stations on AM band.
 - All available radio stations with sufficient signal strength will be stored. Up to 40 presets may be stored.

Notes:

- EASY SET will start with the FM band, if there are still presets available, the system will continue to store the AM band.
- When EASY SET is used, all previously stored radio stations will be replaced.
- The last preset radio station will appear on the display when EASY SET is completed.

Switching the system ON

- Press **STANDBY ON** (on the system only), **CD, TUNER, TAPE** or **AUX**.

You can also switch on the system by pressing any one of the CD DIRECT PLAY buttons.

Switching the system to standby mode

- Press **STANDBY ON** again or **⏻** on the remote control.
 - The system will switch to standby mode.

Selecting the Source

- Press the respective source selection button: **CD, TUNER, TAPE** or **AUX**.
 - The display indicates the selected source.

Note:

- For an external source, make sure you have connected the audio left and right OUT terminals of the external equipment (TV, VCR, Laser Disc player, DVD player or CD Recorder) to the AUX/CDR IN terminals.

Selecting the Equalizer Display

You can select the desired equalizer display for the system. You must not press the DSC or INCREDIBLE SURROUND buttons on the system before using the JOG.

- Rotate the **JOG** to select the desired Equalizer Display, NORMAL, TOP DOWN, or NITE MODE.
→ The selected display will be shown.

NORMAL Display



TOP DOWN Display



NITE MODE Display



Note:

- In NITE MODE, all lights will be switched off and the display brightness will be dimmed.

Sound Control

VOLUME ADJUSTMENT

Adjust **VOLUME** to increase or decrease the sound level.

For Personal Listening

Connect the headphones plug to the  socket at the front of the system. The speakers will be muted.

INCREDIBLE SURROUND

Normal stereo sound is determined by the distance between the front speakers. When Incredible Surround is switched on, it magnifies the virtual distance between the front speakers for an incredibly wide, enveloping, stereo effect. There are 12 different Incredible Surround levels available for selection.

- Press **INCREDIBLE SURROUND** to switch on.
→ The **INCREDIBLE SURROUND** display lights up.
→ "IS XX" will be displayed.

Note:

- "XX" is the last selected Incredible Surround level.

You can change the Incredible Surround level with the JOG.

- Rotate the **JOG** to select the desired Incredible Surround level immediately after selecting the Incredible Surround feature.
→ The Incredible Surround level will increase or decrease between level 1 and 12.

To switch off Incredible Surround

- Press **INCREDIBLE SURROUND** again.
→ The **INCREDIBLE SURROUND** display is switched off.
→ "IS OFF" will be displayed.

DIGITAL SOUND CONTROL (DSC)

The DSC feature enables you to adjust the system to suit your type of music.

- Press **DIGITAL SOUND CONTROL (DSC)** to select OPTIMAL, CLASSIC, TECHNO, JAZZ, ROCK or VOCAL.
→ The selected digital sound is encircled.
→ "OPTIMAL X, CLASSIC, TECHNO X, JAZZ X, ROCK X or VOCAL X" will be displayed. "X" is the pre-selected level.

You can change the digital sound setting level for all but CLASSIC with the JOG.

- First select the DSC feature, then rotate the **JOG** until the desired digital sound setting level is reached.
→ The digital sound setting level will increase or decrease between level 1 and 5.

Note:

- For neutral setting, select CLASSIC and switch off DBB.

DYNAMIC BASS BOOST (DBB)

There are three DBB settings to enhance the bass response.

- Press **DBB** briefly to select a bass boost level.
→ The respective DBB level is being encircled and lit.
→ "BEAT, PUNCH or BLAST" will be displayed.

To switch off DBB

- Press **DBB** briefly until "DBB OFF" is displayed.

Note:

- Some CDs or tapes might be recorded in high modulation. It may cause a distortion at high volume. If this occurs, switch off DBB or reduce the volume.

Automatic DSC-DBB selection

The best DBB setting is generated automatically for each DSC selection. You can manually select the DBB setting that best suits your listening environment.

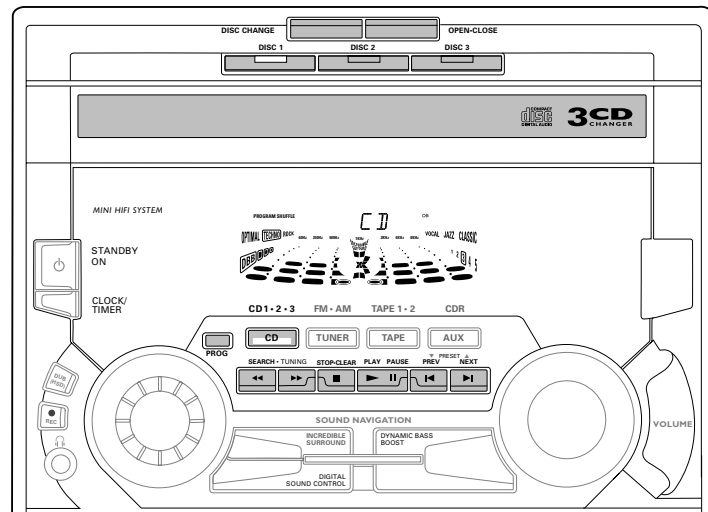
**Warning!**

- 1) This system is designed for conventional CDs. Do not use any accessories such as disc stabilizer rings or CD treatment sheets, etc., which may damage the CD mechanism.**
- 2) Do not load more than one disc into each tray.**
- 3) When the CD changer is loaded with CDs, do not turn over or shake the system. This may jam the changer.**

You may load three discs in the CD changer for continuous playback without interruption.

Disc for playback

This system can playback all audio CD, finalized audio CD-Recordable and finalized audio CD-Rewritable format discs.



Loading the CD Changer

- 1 Press **CD** to select CD mode.
- 2 Press **OPEN•CLOSE**.
→ The CD carousel slides out.
- 3 Load a CD with the printed side up in the right tray.
 - You can load another disc in the left tray.
 - To load the third disc, press the **DISC CHANGE** button.
→ The CD carousel will rotate until the empty tray is ready for loading.
- 4 Press **OPEN•CLOSE** to close the CD carousel.
→ The total number of tracks and the playing time of the last selected disc appear on the display.

Note:

– To ensure good system performance, wait until the CD changer completely reads the disc(s) before proceeding.

CD Direct Play

You can play a CD directly by pressing the **DISC 1**, **DISC 2** or **DISC 3** button. The CD player will stop at the end of playback of the selected disc.

- A lit button indicates that a disc is loaded in the disc tray.

Playing a CD

- 1 Press **PLAY ▶** to start playback.
→ The disc tray, track number and elapsed playing time of the current track appear on the display.
 - To interrupt playback, press **PAUSE II**.
→ The playing time flashes.
 - To resume playback, press **PLAY ▶** again.
- 2 To stop playback, press **STOP•CLEAR ■**.

Note:

– All the available discs will play once, then stop.

Disc Change

You can change the outer two discs while the third inner disc is stopped or is playing.

- 1 Press **DISC CHANGE**.
→ The CD carousel slides out.
- 2 Replace the discs in the left and right disc trays.
 - If you press **DISC CHANGE** again during playback, the CD will stop playing.
→ The CD carousel will rotate until the inner tray is rotated out and is ready for loading.
- 3 Press **OPEN•CLOSE** to close the CD compartment.

Selecting a desired track

Selecting a desired track when playback is stopped

- 1 Press **PREV ◀** or **NEXT ▶** until the desired track appears on the display.
- 2 Press **PLAY ▶** to start playback.
→ The selected track number and elapsed playing time appear on the display.

Selecting a desired track during playback

- Press **PREV ◀** or **NEXT ▶** until the desired track appears on the display.
→ The selected track number and elapsed playing time appear on the display.
- If you press **PREV ◀** once it will skip to the beginning of the current track and play the track again.

Searching for a particular passage during playback

- Press and hold **◀◀** or **▶▶** until the desired passage is located.
→ The volume will be reduced.
- Play returns to normal when **◀◀** or **▶▶** is released.

Programming Tracks

Programming tracks of a loaded CD is possible when playback is stopped. The display will indicate the total tracks stored in the program. Up to 40 tracks can be stored in the memory in any order. When 40 tracks are stored and you attempt to store another track, the display will show "FULL".

- 1 Load the desired discs in the disc trays.
- 2 Press **PROGRAM** to start programming.
→ The **PROGRAM** flag starts flashing.
→ It will cancel any previously selected repeat mode.
- 3 Press the **CD (CD 1•2•3)** button to select the disc.
- 4 Press **PREV ◀** or **NEXT ▶** to select the desired track.
- 5 Press **PROGRAM** to store the track.
 - Repeat steps **3** to **5** to store other discs and tracks.
- 6 Press **STOP•CLEAR ■** once to end programming.
→ The total number of tracks programmed and total playing time appear on the display.

Notes:

– If the total playing time is more than "99:59" or if one of the programmed tracks has a number greater than 30, then "– : – : –" appears on the display instead of the total playing time.

- During programming, if no button is pressed within 20 seconds, the system will exit program mode automatically.

Reviewing the program

Reviewing of the program is possible only when playback is stopped.

- Press **PREV** ◀ or **NEXT** ▶ repeatedly to review the programmed tracks.
- Press **STOP•CLEAR** ■ to exit review mode.

Playing the program

- 1 Press **PLAY** ▶ to start program playback.
 - "PLAY PROGRAM" appears on the display.
 - The track number and elapsed playing time of the current track will appear on the display.
- If you press **REPEAT** during program playback, the current track or all programmed tracks will be played repeatedly.
 - "REPEAT TRACK" or "REPEAT PROGRAM" will be displayed.
 - The **REPEAT** and **PROGRAM** flags will be displayed.
- 2 Press **STOP•CLEAR** ■ to stop program playback.

Notes:

- If you press any of the CD DIRECT PLAY buttons, the system will play the selected disc or track and the stored program will be ignored temporarily. The PROGRAM flag also will disappear temporarily from the display. It will reappear when playback of the selected disc ends.
- REPEAT DISC mode will be cancelled when program playback begins.

Erasing the program (when playback is stopped)

- Press **STOP•CLEAR** ■ .
 - "PROGRAM CLEARED" will be displayed.

Note:

- The program will be erased when the system is disconnected from the power supply or when the CD carousel is opened. If the CD carousel is opened, the tracks belonging to the outer two trays will be erased and the display will show "TRACKS CLEARED".

Shuffle (only on remote control)

In shuffle mode, the system plays all the available discs and their tracks in random order. Shuffle may be used also when tracks are programmed.

To shuffle all the discs and tracks

- 1 Press **SHUFFLE**.
 - "SHUFFLE" will be displayed.
 - The **SHUFFLE** flag, the disc and the track selected at random appear on the display.
- The discs and the tracks will be played in random order until you press **STOP•CLEAR** ■ .
- If you press **REPEAT** during shuffling, the current track or all available discs will be played repeatedly.
 - "TRACK" or "ALL" will be displayed.
 - The **REPEAT** and **SHUFFLE** flags will be displayed.
- 2 Press **SHUFFLE** again to resume normal playback.
 - The **SHUFFLE** flag disappears from the display.

Note:

- REPEAT DISC mode will be cancelled when shuffle is selected.

Repeat (only on remote control)

You can play the current track, a disc or all available discs repeatedly.

- 1 Press **REPEAT** on the remote control during CD playback to select the various repeat modes.
 - "TRACK", "DISC", "ALL" or "OFF" will be displayed.
 - The **REPEAT** flag appears on the display.
- The selected track, selected disc or all available discs will now be played repeatedly until you press **STOP•CLEAR** ■ .
- 2 Press **REPEAT** until the "OFF" mode is displayed to resume normal playback.
 - The **REPEAT** flag disappears from the display.

Notes:

- REPEAT DISC mode is not available during program play or shuffling mode.
- You can also repeat shuffling a program.
 - "REPEAT TRACK" or "REPEAT PROGRAM" will be displayed.
 - The **REPEAT**, **PROGRAM** and **SHUFFLE** flags appear on the display.

General Information

- With your Philips CD Recordable/ ReWritable Recorder, you can record, play and erase your own high-quality audio CDs, subject to legal restrictions on copying. Naturally, you will also be able to play all pre-recorded audio CDs.
- For recording use, special audio discs must be used (for music only). These discs bear the logos as shown below. The text 'DIGITAL AUDIO' is present!
 - *CD-Audio Recordable (CDR) discs*: fully recorded and finalized, these discs play on all CD players and recorders.
 - *CD-Audio ReWritable (CDRW) discs*: can be recorded, erased and re-recorded hundreds of times. When finalized, they play on CDRW compatible CD players and recorders. In the course of 1999 most Philips CD players and recorders will be CDRW compatible.
- To ensure proper working of the set we recommend the use of Philips audio CDR and audio CDRW discs only.
- Your CD Recorder is able to playback all audio CD, finalized audio CD-Recordable and finalized audio CD-ReWritable format discs.



Accessories (Supplied)

- 2 Analog audio cables (with red and white plugs)
- 1 Digital coaxial cable (with black plugs)
- Power cord

DISPLAY indications

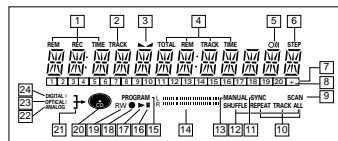

- 1 REM/REC TIME**
 - remaining recording time/recording time.
- 2 TRACK**
 - track number.
- 3**
 - balance (lights up during balance adjustment).
- 4 TOTAL REM TRACK TIME**
 - total or remaining time of disc or track.
- 5**
 - remote control active.
- 6 STEP**
 - indicates the number of tracks in a program.
- 7 Track bar**
 - indicates tracks on a disc or in a program.
 - indicates track in playback.

- 8 +20**
 - disc or program contains more than 20 tracks.
- 9 SCAN**
 - lights up when the first 10 seconds of each track are played.
- 10 REPEAT TRACK/ALL**
 - lights up when a track/complete disc (or program) is repeated.
- 11 SYNC**
 - synchronized recording active.
- 12 SHUFFLE ALL**
 - plays tracks in random order.
- 13 MANUAL**
 - manual recording active.
- 14 L/R II II**
 - record/play level bar, indicates the audio signal level.
- 15 PROGRAM**
 - flashes during programming/lights in program mode.
- 16 II**
 - pause function active.
- 17 ▶**
 - lights up during playback.
- 18 ●**
 - lights up during recording.
- 19 RW**
 - unfinalized CDR(W) disc inserted.
- 20 CD**
 - CD inserted (a pre-recorded CD or finalized CDR or CDRW disc).
- 21 }→**
 - lights up during recording.

- 22 ANALOG**
 - analog input selected.
- 23 OPTICAL I**
 - optical input I selected for external recording.
- 24 DIGITAL I**
 - digital input I selected for external recording.

DISPLAY messages

Messages, as listed and explained here, may appear on the display for your guidance.

GENERAL

READING reading disc information.
NO DISC no disc inserted, disc unreadable or disc inserted upside down.
PROG FULL program full.
INSERT DISC ... insert disc or insert disc in correct way.
WRONG DISC ... inserted disc is not audio CD.
UNFINALIZED ... unfinalized CDR(W) disc.
MEMORY XX% ... indicates the amount of text memory used for unfinalized discs.

RECORDING

UPDATE updating disc contents.
DISC FULL no more recording possible.
COPY PROTECT ... no digital recording can be made of the connected source.
NOTFINALIZED ... when opening the tray with an unfinalized disc inserted.
MAKE CD start of synchronized recording of a complete disc and Auto Finalize function selected.

RECORD DISC ... start of synchronized recording of a complete disc.
RECORD TRACK ... start of synchronized recording of a single track.
REC MANUAL manual start of recording selected.
-XX DB level is being adjusted.
ERASE TRACK ... when erasing one or more tracks.
ERASE DISC when erasing a disc.
FINALIZE when finalizing a disc.
FINALIZED when trying to finalize an already finalized disc.
CHECK INPUT ... when RECORD is pressed while no digital source is detected.
PRESS RECORD ... to start manual recording, finalizing or erasing.
START SOURCE ... to start synchronized recording from a source.
FINALIZED CD ... when trying to record on a finalized CDR or a prerecorded CD.
UNFINALIZE / PRESS ENTER when trying to record on a finalized CDRW.

OTHERS

NO AUDIO TR ... when the recorder enters a data track during recording.

FINALIZE CD ... laser power calibration performed 96 times, finalize disc.
INITIALIZING ... during laser power calibration for unfinalized discs.
OPC ERROR OPC failure during OPC procedure (OPC = Optimum Power Calibration).
RECORD ERROR ... recording error in menu mode.
DISC ERROR when trying to record on or finalize a recovered disc.
MEMORY FULL / FINALIZE CD when text memory is full.
 To add a CD to the list, first finalize or erase another disc from the list.

MENU MESSAGES

NO TRACKS when attempting to edit text for a disc which has no tracks.
CD ARTIST when editing or erasing an artist name.
CD TITLE when editing or erasing a title.
TR N ARTIST ... when editing or erasing an artist name per track.

TR N TITLE when editing or erasing a title per track.
ERASE OK / ERASE ALL OK when confirmation for erasing has to be given with ENTER key.
ERASE MEMORY ... when waiting for confirmation when erasing a disc.
MEMORY VIEW ... when selecting text review per unfinalized disc in memory.
MEMORY EMPTY ... when REVIEW is selected while no text is in memory.
AUTO TRACK when selecting auto track increment ON or OFF.
ON Auto Track increment on.
OFF Auto Track increment off.
NO TEXT no text stored for disc.

Switching the system ON

- 1 Plug the power cord supplied into the MAINS connector on the CD recorder, then into a mains socket.
- 2 Press **ON/OFF**.
→ The recorder is now in Standby mode.
- 3 Press any key to activate the recorder.

Notes:

- The CD recorder will automatically adjust to the local mains voltage.
- When the CD recorder is in the 'OFF' position, it is still consuming some power. If you wish to disconnect your player completely from the mains, withdraw the plug from the AC outlet.

Inserting discs

- 1 Press **OPEN/CLOSE** to open the disc tray.
- 2 Insert a CD, CDR or CDRW in the appropriate recess in the tray, label side up.
- 3 Press **OPEN/CLOSE** to close the tray.
→ "CLOSE" lights up, followed by "READING" and the type of disc you inserted appears on the display.
 - If a CDR(W) is finalized it will show **cd** on the display.
 - If CD-text is available the TITLE/ARTIST will scroll by.

Notes:

- Only Audio CDs will be accepted. If a non-audio disc is inserted, the display shows "WRONG DISC".
- If you insert a blank or partly-recorded CDR or unfinalized CDRW, the CD recorder will calibrate the disc for optimum recording. During this process the display will first show "INITIALIZING" and then the number of audio tracks. Calibration can take up to 25 seconds.

Recording

Important:

- **If you want to play the recorded CDR disc on any regular CD player, it must first be finalized. See finalizing discs.**
- **Finalized CDRW discs play only on CDRW compatible CD players.**
- **For recording from CD-changers, do not use Manual Recording.**
- **Only make analog recordings when digital recording is not possible.**
- **If the disc already contains recordings, the CD recorder will automatically search for the end of the last track, so that recording can start from there.**
- **There must be at least 7 seconds of recording time left on the disc, otherwise you will not be able to enter record standby mode. "DISC FULL" then lights up.**

- **A maximum of 99 tracks can be recorded on a disc. Minimum allowable track length is 4 seconds.**

AUTOSTART RECORDING

This feature enables you to make fast and easy recordings of a CD. Track increments are automatically detected from the source material. Track increments cannot be added manually. In analog source material a silence of 2.7 seconds or more is automatically detected as a track increment.

Preparing for autostart recording

- 1 Make sure the disc is absolutely free of scratches and dust particles.
- 2 Press **SOURCE** repeatedly to select DIGITAL, OPTICAL or ANALOG mode.
→ The **DIGITAL I**, **OPTICAL I** or **ANALOG** flag lights up.
→ "DIGITAL I, OPTICAL or ANALOG" appears on the display.
- 3 Press **REC TYPE** *once* to record a complete disc; or *twice* to record a single track; or *four times* to record a complete disc with Auto-Finalize function selected.
→ The **sync** flag starts flashing.
→ "RECORD DISC, RECORD TRACK or MAKE CD" appears on the display.

Start autostart recording

- 1 Start playback on the selected source.
→ The CD recorder automatically starts to record.
 - To check the elapsed recording time, press **DISPLAY**.
 - The recorder will stop automatically at the end of recording.
- 2 To stop recording manually, press **STOP** ■ on the CD Recorder.
→ The **sync** flag disappears and the display shows "WAIT".
 - If **STOP** ■ was pressed within 3 seconds after starting playback, no recording will take place.
 - To interrupt recording, press **PAUSE II** on the CD Recorder.
 - To resume recording, press **RECORD** on the CD Recorder.

After recording, the display will show "UPDATE" for several seconds.

Note:

- Recordings from DAT, DCC or analog sources will only stop after 20 seconds silence.

MANUAL RECORDING

Preparing for manual recording

- 1 Press **SOURCE** repeatedly to select DIGITAL, OPTICAL or ANALOG mode.
 - When Auto Track is ON (default setting), track numbers will automatically be increased during recording.
 - To switch off the Auto Track function you have to enter Menu mode. If you wish to increase track numbers manually, press TRACK INCREMENT on the remote control. For further instructions see Menu mode.
- ON (AUTO) The track increments are automatically taken over from the digital source material or after 2.7 seconds silence during analog recording.
 - ON (MANUAL) ... Track numbers can be incremented manually by pressing TRACK INCR(ement) on the remote control. (Minimum track length is 4 sec.) (This can also be done in Auto mode).
- Track numbers cannot be changed after recording.
- 2 Press **REC TYPE** three times to enter the Manual Record standby mode.
 - The **MANUAL** flag starts to flash and the display shows "REC MANUAL".

- 3 Play the source first to set the optimal recording level on the CD recorder.
- 4 Rotate **EASY JOG** until all the blue segments are alight on the record/play Level Bar, but the red segments do not light continuously during the loudest passages.
 - "-XX BB" appears on the display.
- 5 Stop the source.

Start manual recording

- 1 To start recording, press **RECORD** on the CD Recorder and immediately start playback of the selected source (*from Stop-mode*).
 - The track number and recording time appear on the display.
- To record a 3-second silence at the start of a track, press **PAUSE II** on the CD Recorder before starting the selected source.
- To check the elapsed recording time, press **DISPLAY** on the CD recorder (This can also be done during the recording).
- 2 To stop recording, press **STOP ■** on the CD recorder.
 - "WAIT" appears on the display.
- If **STOP ■** was pressed within 3 seconds after pressing **RECORD**, no recording will take place.
- To interrupt recording, press **PAUSE II** on the CD recorder.

After recording, the display will show "UPDATE" for several seconds.

Note:

- With "AUTO TRACK ON", the recorder will stop and go to REC STANDBY for 1 minute and then goes to stop mode automatically. Recordings from DAT, DCC or recordings made analogously will stop after 20 seconds silence. With "AUTO TRACK OFF", the auto stop mode is disabled.

FINALIZING CDR & CDRW DISCS

Finalizing is a simple procedure, necessary to:

- be able to play recordings on a CD PLAYER,
- avoid further unwanted recordings on a disc,
- avoid erasure of tracks on a CDRW.

Auto finalizing

Auto finalizing is possible when using the MAKE CD recording function.

Manual finalizing

- 1 Press **FINALIZE** in stop mode.
 - "FINALIZE" and "PRESS RECORD" appear on the display.
- 2 Press **RECORD**.
 - "XX XX FINAL" and the approximate finalization time appear on the display.
- The display counts down through the finalization.
 - On completion, the total number of tracks and the total time recorded appear on the display.

- For CDR(W), **CDR(W)** changes to **CD** on display.

Notes:

- Finalizing will take at least 2-4 minutes.
- During finalization, the CD recorder accepts no operating commands.

UNFINALIZING CDRW DISCS

For CDRW discs only

If you want to make more recordings (or erasures of tracks) on a finalized disc you must unfinalize it first. The Table of Contents (TOC) will be removed.

To unfinalize

- 1 Press **REC TYPE** or **ERASE** in stop mode.
 - "UNFINALIZE" and "PRESS ENTER" appear on the display.
- 2 Press **ENTER** to confirm unfinalize.
 - The disc will now be unfinalized and can be recorded on again.

Notes:

- Unfinalizing will take approximately 2 minutes.
- When unfinalizing a CDRW disc with text on it available, this text will be transferred to the CD recorder memory. It may occur that the text memory is full. The message "MEMORY FULL / FINALIZE CB" will be displayed. You will now have to erase text, stored for other discs, or finalize another disc in order to obtain memory space.

ERASING CDRW DISCS

For unfinalized CDRW discs only

You can erase:

- one or more tracks from the end,
- the entire disc.

To erase one or more tracks from the end

1 Press **ERASE once**.

- The number of tracks and their total playing time appear on the display.
- “ERASE TRACK” and “PRESS RECORD” appear on the display.

- If the disc is finalized, **CD** appears on the display after inserting a CDRW in the recorder. The recorder will ask you to confirm unfinalizing first. Confirm by pressing the **ENTER** button.

- #### 2 Select the track(s) you wish to erase by turning the **EASY JOG** button to the left and confirm by pressing this button.
- The selected track numbers start blinking on the track bar.
 - The remaining number of tracks and the remaining playing time after erasing the selected track(s) appear on the display.

3 Press **RECORD**.

- “ERASE” and the total countdown time appear on the display.
- After the selected track(s) have been erased, the display shows the remaining tracks and their total playing time.

To erase the entire disc

1 Press **ERASE twice**.

- The number of tracks and their total playing time appear on the display.
- “ERASE DISC” and “PRESS RECORD” appear on the display.

- If the disc is finalized, **CD** appears on the display after inserting a CDRW in the recorder. The recorder will ask you to confirm unfinalizing first. Confirm by pressing the **ENTER** button.

2 Press **RECORD**.

- “ERASE” and the total countdown time appears on the display.
- The complete disc will be erased.

Playback

PLAYING A CD

1 Press **PLAY** ► to start CD playback.

- The track number and elapsed playing time of the current track appear on the display.

2 Press **DISPLAY** once, twice or three times to see:

- Remaining track time, total remaining time or text information respectively.

3 To interrupt playback temporarily, press **PAUSE II**.

4 To continue playback, press **PLAY** ► again.

5 To stop playback, press **STOP** ■.

- The number of tracks and the total playing time appear on the display.

SELECTING A DESIRED TRACK

Selecting a track during playback

1 Turn the **EASY JOG** button (or press **◀ / ▶** on the remote control) until the required track number appears on the display.

- The selected track number and elapsed playing time appear on the display.

- If you press **◀** once it will skip to the beginning of the current track and play the track again.

Selecting a track when CD playback is stopped

1 Turn the **EASY JOG** button (or press **◀ / ▶** on the remote control) until the required track number appears on the display.

2 Press **ENTER** for confirm or **PLAY** ► to start playback.

Note:

- You can also key in the required track number using the numerical keys on the remote control.

SEARCH

1 Hold down **REWIND** ◀◀ or **FFWD** ▶▶.

- The player first searches backwards or forwards at 10 times normal speed with sound at low volume, then goes to 50 times normal speed with sound muted.

2 Release the button at the desired passage.

- Playback starts at the desired passage.

Note:

- During Shuffle, Repeat Track or Programmed play, search is restricted to within the track being played at the time.

SHUFFLE (only on remote control)

1 Press **SHUFFLE** before or during CD playback.

- The **SHUFFLE** flag lights up.
- The tracks on the CD (or program if set) play in random order.

2 Press **SHUFFLE** again to return to normal CD playback.

Note:

- **SHUFFLE** will be cancelled if you open the disc tray.

REPEAT CD, TRACK OR PROGRAM

(only on remote control)

1 Press **REPEAT** during CD playback to select the various repeat modes.

- When **REPEAT TRACK** flag lights up, the current track plays repeatedly.
- When **REPEAT ALL** flag lights up, the disc or program plays repeatedly.

2 To return to normal playback, press **REPEAT** until:

- The **REPEAT** flag disappears from the display.

Notes:

- You can use **Shuffle** in combination with repeat all or programmed playback.
- **REPEAT** will be cancelled if you open the disc tray.

Programming

- You can program up to 99 tracks to play in any desired sequence.
 - Tracks can be programmed more than once, but each time counts as a track (**STEP**).
- 1 In Stop mode, press **PROG** on the remote control to enter Program mode.
 - The **PROGRAM** flag starts flashing and "PROGRAM" appear on the display.
 - 2 Select the required track numbers by turning **EASY JOG** left or right (*or Digit 0-9 on the remote control*) and store by pressing **ENTER** button .
 - The track will be stored in the program.
 - The track number, total program time and the number of programmed tracks (**STEPS**) appear on the display.
 - 3 Repeat **step 2** for all tracks to be programmed.
 - 4 Press **STOP** ■ or **PROG** again on the remote control to end programming.
 - 5 Press **PLAY** ► to start programmed playback.

Notes:

- To review the program, press **PROG** on the remote control, followed by ◀◀ or ▶▶ with the CD recorder in Stop mode.
- If you try to store more than 99 tracks, "PROG FULL" appears on the display.

Clearing a program

- 1 Press **STOP** ■ if necessary to stop programmed playback.
 - 2 Press **STOP** ■ again to clear the program.
 - The **PROGRAM** flag disappears from the display.
- The program is also cleared if you open the disc tray.

Erasing a track from a program

- 1 In Stop mode, press **PROG** on the remote control to enter Program mode.
- 2 Use ◀◀ or ▶▶ to select the track from which to delete.
 - The track number and program step appear on the display.
- 3 Press **CANCEL** to erase the track from the program.
 - The remaining program steps and the remaining playing time of the program will be displayed.

Menu mode

- In Menu mode you will have access to a number of features which are not available via the regular keys (on the deck's front and the remote control).
- The **TEXT** submenus allow you to give names to discs and tracks. The disc and track names will be displayed during playback.
- In the **RECORDING** submenus you can set Auto Track and Balance.
- All settings (except Balance) made in Menu mode will be stored in the deck's memory and can be called up and changed at any time.

General Operation

- 1 In Stop mode, select **CDR**.
- 2 Press **STORE/MENU** to enter Menu mode.
 - "TEXT EDIT" appears on the display.
- 3 Rotate **EASY JOG** to select the required submenus and press **ENTER** to confirm.
- 4 Rotate **EASY JOG** to select options in the submenu and press **ENTER** to confirm.
- 5 Press **STORE/MENU** to store settings and return to the submenu.
- 6 Press **STOP** ■ to store settings and exit Menu mode.

Note:

- Text can only be edited for unfinalized discs. (Finalized CDRW discs must be unfinalized first.)

TEXT SETTINGS**Storing names**

- 1 Select the **TEXT EDIT** submenu.
 - "TEXT EDIT" appears on the display.
- 2 Press **ENTER** to confirm.
- 3 Rotate **EASY JOG** to select the required option in the submenu: **CD ARTIST**, **CD TITLE**, **TRACK 1 ARTIST**, **TRACK 1 TITLE**, etc.
- 4 Press **ENTER** to confirm.
- 5 Select the characters by rotating the **EASY JOG** button.
 - To insert a space between characters, press **ENTER** without selecting a character first.
 - To delete a character, press **CANCEL**.
- 6 Press **ENTER** to store the characters and move to the next cursor position.
 - To move to a required cursor position, press ◀◀ or ▶▶.
- 7 Press **STORE/MENU** to store a name you have entered and return to the submenu or **STOP** ■ to exit.

Notes:

- A maximum of 60 characters can be stored per item.

- When an artist's name has been stored for a certain track, the name will automatically be copied for the next track. The name can be confirmed by pressing **STORE/MENU** or a new name can be entered as described above.

Erasing names

- 1 Select the **TEXT ERASE** submenu.
 - "TEXT ERASE" appears on the display.
- 2 Press **ENTER** to confirm.
- 3 Rotate **EASY JOG** to select the required option in the submenu: ALL TEXT, CD TITLE, CD ARTIST, TRACK 1 TITLE, TRACK 1 ARTIST, etc.
- 4 Press **ENTER** to confirm.
 - The display will ask you to reconfirm your selection, press **ENTER** again to reconfirm.
- 5 Press **STORE/MENU** to return to the submenu or **STOP ■** to exit.

Text Memory Review/Erase Text Memory

- 1 Select the **MEMORY VIEW** submenu.
 - "MEMORY VIEW" appears on the display.
- 2 Press **ENTER** to confirm.
- 3 Select the disc you wish to erase and press **ENTER** to confirm.
 - "ERASE MEMORY" appears on the display.
- 4 Press **ENTER** to erase.

- 5 Press **ENTER** again to reconfirm the erasure of the text for that particular disc.
- 6 Press **STORE/MENU** to return to the submenu or **STOP ■** to exit.

Notes:

- If there are no discs in the memory, the message "MEMORY EMPTY" appears on the display.
- When the text memory of your CD Recorder is full, the message "MEMORY FULL" will appear, followed by "FINALIZE CD". If you want to add a CD to the list of discs for which text is stored, you have to erase a disc. ("for which text is stored")
- "MEMORY FULL/FINALIZE CD" may also appear when unfinalizing a CDRW disc for which text was stored (see "Unfinalizing CDRW discs"). The same action(s) should be taken in order to obtain memory space.



RECORDING SETTINGS

Auto track increment

- 1 Select the **AUTO TRACKING** sub menu.
 - "AUTO TRACK" appears on the display.
- 2 Press **ENTER** to confirm.
- 3 Select Auto track ON or OFF and press **ENTER** to confirm.
 - "ON" or "OFF" appears for 2 seconds on the display.

- When ON is selected, track numbers will be automatically incremented during recording.
 - When OFF is selected, you can number the recorded tracks yourself.
- 4 Press **STORE/MENU** to store settings and return to the submenu or **STOP ■** to exit.

BALANCE (Only active in Record/Standby mode)

- 1 Select the **SET BALANCE** submenu.
 - "SET BALANCE" appears on the display.
- 2 Press **ENTER** to confirm.
 -  and L- 128 R- 128 appear on the display.
- 3 Adjust recording balance by rotating the **EASY JOG** button.
 - Turn left: the figure left () counts up, right counts down.
 - Turn right: the figure right () counts up, left counts down.
- 4 Press **ENTER** to confirm.
- 5 Press **STORE/MENU** to store settings.

Note:

- The balance setting will not be stored.

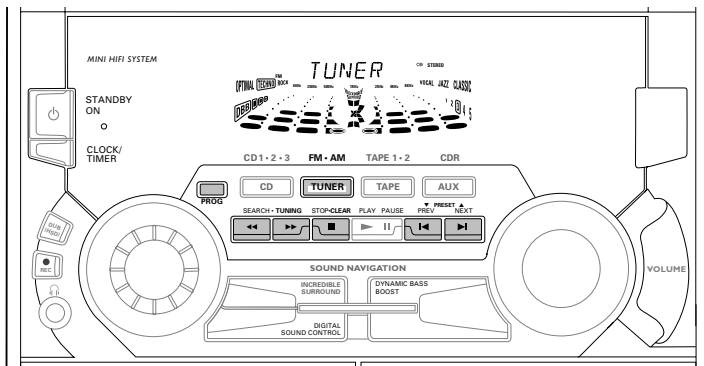

Note:

- For 'EASY SET' feature, please refer to page 13.

Tuning to radio stations

- 1 Press **TUNER** (FM•AM) to select TUNER mode.
→ "TUNER" will be displayed.
A few seconds later, the current radio frequency will be displayed.
 - 2 Press **TUNER** (FM•AM) again to select the desired waveband: FM or AM.
 - 3 Press **TUNING** ◀◀ or ▶▶ for more than one second, then release.
→ The display will show "SEARCH" until a radio station with sufficient signal strength is found.
- Repeat this procedure until the desired station is reached.

- To tune to a weak radio station, briefly press **TUNING** ◀◀ or ▶▶ repeatedly until the display shows the desired frequency and/or when the best reception has been obtained.

Storing Preset Stations

You can store up to 40 radio stations in the memory. When a preset radio station is selected, the preset number appears next to the frequency on the display.

Automatic programming

- 1 Press **TUNER** (FM•AM).
- 2 Press **PROGRAM** for more than one second.
→ The **PROGRAM** flag starts flashing and "AUTO" will be displayed.

- The system will search for every available station in the FM waveband first, then search by the AM waveband.
- All available radio stations will be stored automatically. The frequency and preset number will be displayed briefly.
- The system will stop searching when all the available radio stations are stored or when the memory for 40 preset radio stations is used.
- The system will remain tuned to the last stored preset radio station.

Notes:

- You can cancel the automatic programming by pressing **PROGRAM** or **STOP•CLEAR** ■ (on the system only).
- If you want to reserve a section of preset numbers, for example preset numbers 1 to 9, select preset 10 before starting automatic programming: only the preset numbers 10 to 40 will be programmed.

Manual programming

- 1 Press **TUNER** (FM•AM).
- 2 Press **TUNER** (FM•AM) again to select the desired waveband: FM or AM.
- 3 Press **PROGRAM** for less than one second.
→ The **PROGRAM** flag starts flashing.
→ The next available preset number will be displayed for selection.

- 4 Press **TUNING** ◀◀ or ▶▶ to tune to the desired frequency.
- If you wish to store the radio station to another preset number, press **PRESET** ▼ or ▲ to select the desired preset number.
- 5 Press **PROGRAM** again.
→ The **PROGRAM** flag disappears and the radio station will be stored.
- Repeat the **steps 3 to 5** to store other preset radio stations.

Notes:

- When 40 radio stations are stored and you attempt to store another radio station, the display will show "FULL". If you want to change an existing preset number, repeat steps 3 – 5.
- You can cancel manual programming by pressing **STOP•CLEAR** ■ (on the system only).
- During programming, if no button is pressed within 20 seconds, the system will exit program mode automatically.

Tuning to Preset Radio Stations

- Press **PRESET** ▼ or ▲ to select the desired preset number.
→ The preset number, radio frequency, and waveband appear on the display.

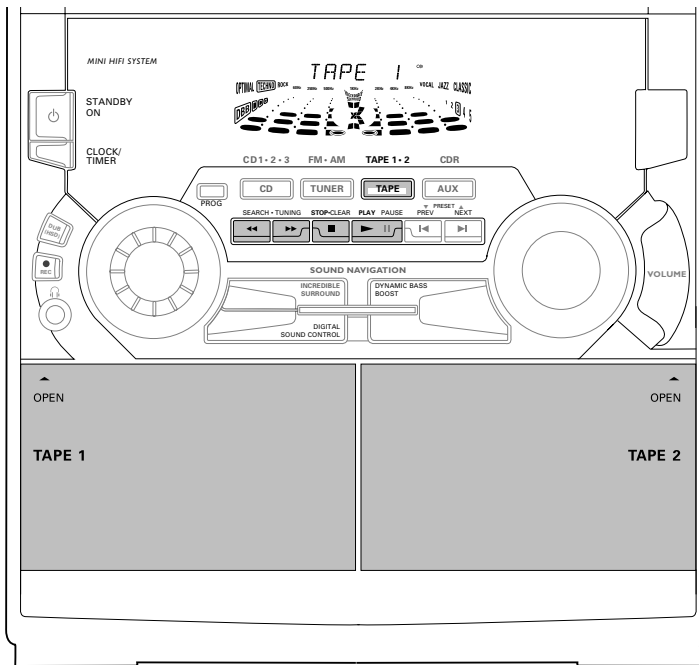

Loading a tape

- Press **OPEN**.
- The tape deck door opens.
- Load the tape with the open side downward and the full spool to the left.
- Close the tape deck door.

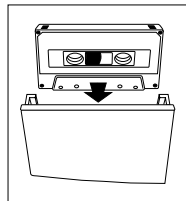

Tape Playback

- 1 Press **TAPE** (TAPE 1•2) to select TAPE mode.
→ "TAPE 1" or "TAPE 2" will be displayed.
- Press **TAPE** (TAPE 1•2) again to select either tape deck 1 or tape deck 2.
- 2 Load the tape into the desired tape deck.
- 3 Press **▶** to start playback.
- 4 Press **■** to end playback.

Rewind/Fast Forward (only on tape deck 2)

When playback is stopped

- 1 You can rewind or fast forward the tape by pressing **◀◀** or **▶▶** respectively.
→ "◀◀◀" or "▶▶▶" will be displayed depending on which button is pressed.
→ The tape will stop automatically at the end of the rewinding or fast forwarding.
- 2 Press **■** to stop rewinding or fast forwarding.

During playback

- Press and hold **◀◀** or **▶▶** until the desired passage is located.
→ During searching, the sound is reduced to a low volume.
→ When you release **◀◀** or **▶▶**, the tape continues playing.

Notes:

- During rewinding or fast forwarding of a tape, it is also possible to select another source (e.g. CD, TUNER, or AUX).
- Before use, check and tighten slack tape with a pencil. Slack tape may get jammed or may burst in the mechanism.
- C-120 tape is extremely thin and is easily deformed or damaged. It is not recommended for use in this system.
- Store the tapes at room temperature and do not put them too close to a magnetic field (for example, a transformer, TV, or speaker).

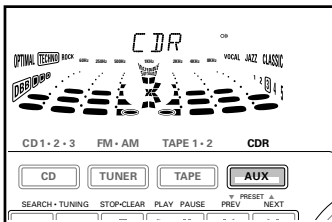

Selecting External Equipment

If you have connected the audio out terminals of the external equipment (TV, VCR, Laser Disc player, DVD player, or CD Recorder) to the AUX/CDR IN terminals, you can hear the enhanced sound from the system.

- Press **AUX** to select AUX-CDR mode.
→ "CDR" will be displayed.
- Press **AUX** again to select the external mode.
→ "AUX" will be displayed.

Notes:

- There are two AUX modes:
 - i. the normal AUX mode.
 - ii. the CDR mode; where the LINE OUT of this mini system is muted. You will not be able to record or listen to the sound from the LINE OUT.
- You are advised not to listen to and record from the same source simultaneously.
- All the sound control features (e.g. DSC, DBB, etc.) are available for selection.

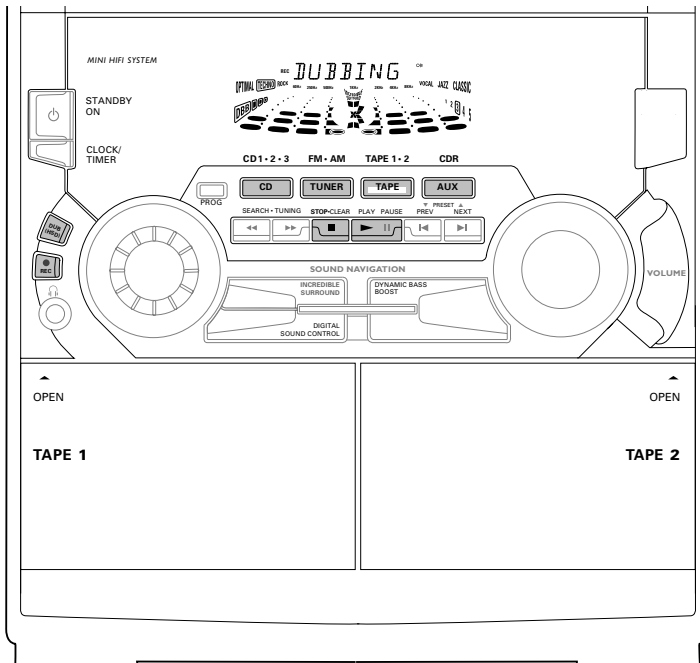

Notes:

- For recording, use only tape of IEC type I (normal tape) or IEC type II (CrO₂).
- The tape is secured at both ends with leader tape. At the beginning and end of tape, nothing will be recorded for six to seven seconds.
- The recording level is set automatically, regardless of the position of Volume, DBB, Incredible Surround or DSC.
- To prevent accidental recording, break out the tab on the left shoulder of the tape side you want to protect.
- If "CHECK TAPE" is displayed, the protection tab has been broken. Put a piece of clear adhesive tape over the opening. Do not cover the CrO₂ tape detection hole when covering the tab opening.

Recording from other sources

(only on tape deck 2)

- 1 Press **TAPE** (TAPE 1•2) to select tape deck 2.
- 2 Load a blank tape into tape deck 2 with the open side downward.
- 3 Press **CD, TUNER** or **AUX**.
 - Start playback of the selected source.
- 4 Press **REC** to start recording.
→ The **REC** flag starts flashing.
- 5 Press **■** to stop recording.

Note:

- During recording, it is not possible to listen to another source.

Dubbing tapes *(from tape deck 1 to tape deck 2)*

- 1 Press **TAPE** (TAPE 1 • 2) to select tape deck 2.
- 2 Load the prerecorded tape into tape deck 1 and a blank tape into tape deck 2.
 - Make sure the tape in tape deck 1 has its full spool to the left.
- 3 Press **DUB (HSD) once** for normal speed dubbing or **twice** *(within 2 seconds)* for high speed dubbing.
 - "NORMAL" (normal speed) or "FAST" (high speed) will be displayed, followed by "DUBBING".
 - The **HSD** flag appears on the display during high speed dubbing.
 - Dubbing will start immediately.
 - The **REC** flag starts flashing.
- 4 Press **■** to stop dubbing.

Notes:

- At the end of side A, flip the tapes to side B and repeat the procedure.
- Dubbing of tapes is only possible from tape deck 1 to tape deck 2.
- To ensure good dubbing, use tapes of the same length.
- During high speed dubbing in Tape mode, the sound is reduced to a low volume.
- You can listen to another source while dubbing.

CD Synchro Start Recording

- 1 Load a blank tape into tape deck 2 and a disc into a disc tray.
- 2 Press **CD** to select CD mode.
 - You can program the tracks in the order you want them to be recorded (see Programming Tracks). If you do not, the tracks are recorded according to the order on the selected disc.
- 3 Press **REC** to start recording.
 - The **REC** flag starts flashing.
 - CD will start playback automatically.
- 4 Press **■** to stop recording.

One Touch Recording

- For One Touch Recording, as soon as you press **REC**, the current source (CD, TUNER or AUX) will be recorded on tape deck 2
- 1 Load a blank tape in tape deck 2.
 - 2 Press **REC** to start recording.
 - The **REC** flag starts flashing.
 - 3 Press **■** to stop recording.

Note:

- When you press **RECORD** while in **TAPE** mode, "SELECT SOURCE" will be displayed. One Touch Recording is not possible in **TAPE** mode.

Digital Recording via Digital Out

For CD digital recording, please refer to CD Recorder.

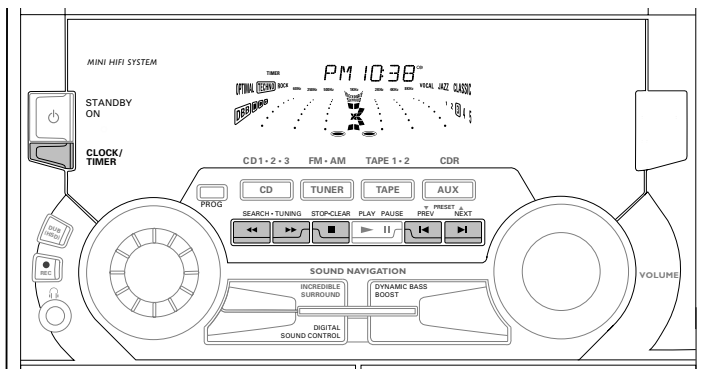

View Clock

You can view the clock (if it is set) while the system is in standby mode or any source mode. It will be displayed for about seven seconds.

- Press **CLOCK/TIMER** briefly (*on the system only*).
 - "PM 10:38" (the current time) will be displayed.
 - "-- : - -" will be displayed if the clock is not set.

Clock Setting

The clock is set in 12-hour mode, e.g. "AM 12:00" or "PM 12:00". Before setting the clock, you must be in the View Clock mode.

- 1 Press **CLOCK/TIMER** to select clock mode.
 - "AM 12:00" or the current time starts flashing.
 - 2 Set the hour with ◀◀ or ▶▶.
 - 3 Set the minute with ◀ or ▶.
 - 4 Press **CLOCK/TIMER** again to store the setting.
 - The clock starts.
- To exit without storing the setting, press **■** on the system.

Notes:

- During clock setting, if no button is pressed within 90 seconds, the system will exit clock setting mode automatically.
- When a power interruption occurs, the clock setting is erased.

Timer Setting

- The system can switch on to CD, TUNER, or TAPE 2 mode automatically at a preset time. It can serve as an alarm to wake you up.
- Before setting the timer, make sure the clock is set correctly.
- The timer will always be switched on once it is set.
- **The volume of the timer will start to increase from the minimum level until the volume level before the set is switched to standby mode.**

- 1 Press and hold **CLOCK/TIMER** for more than two seconds to select timer mode.
 - "PM 12:00" or the last set timer starts flashing. The **TIMER** flag flashes.
 - The last selected source is lit while other available sources are flashing.
- 2 Press **CD**, **TUNER** or **TAPE** to select the desired source.
- Before selecting CD or TAPE, make sure a CD or tape is loaded in the CD tray or tape deck 2.

- 3 Press ◀◀ or ▶▶ to set the hour for the timer to start.
- 4 Press ◀ or ▶ to set the minute for the timer to start.
- 5 Press **CLOCK/TIMER** to store the start time.
 - The timer is now set.
 - The **TIMER** flag remains on the display.
- At the preset time, the timer will be activated.
 - The selected source will be played.

Notes:

- During timer setting, if no button is pressed within 90 seconds, the system will exit timer setting mode automatically.
- If the source selected is **TUNER**, the last tuned frequency will be switched on.
- If the source selected is **CD**, playback will begin with the first track of the last selected disc. If the CD trays are empty, the **TUNER** will be selected instead.
- If the source selected is **TAPE**, and if the preset time is reached during high speed dubbing, the **TUNER** will be selected instead.

To switch off the **TIMER**

- 1 Press **CLOCK/TIMER** for more than two seconds.
- 2 Press **■** on the system to cancel the timer.
 - The timer is now switched off.
 - The display will show "OFF" and the **TIMER** flag disappears.

To start the **TIMER** again *(for the same preset time and source)*

- 1 Press **CLOCK/TIMER** for more than two seconds.
- 2 Press **CLOCK/TIMER** again to store the start time.
 - The timer is now switched on.
 - The **TIMER** flag appears on the display.

Maintenance

Cleaning the Cabinet

- Use a soft cloth slightly moistened with a mild detergent solution. Do not use a solution containing alcohol, spirits, ammonia or abrasives.

Cleaning Discs

- When a disc becomes dirty, clean it with a cleaning cloth. Wipe the disc from the center out.
- Do not use solvents such as benzene, thinner, commercially available cleaners, or antistatic spray intended for analog records.



Cleaning the CD lens

- After prolonged use, dirt or dust may accumulate at the CD lens. To ensure good playback quality, clean the CD lens with Philips CD Lens Cleaner or any commercially available cleaner. Follow the instructions supplied with cleaner.

Cleaning the Heads and the Tape Paths

- To ensure good recording and playback quality, clean the heads, the capstan(s), and pressure roller(s) after every 50 hours of tape operation.
- Use a cotton swab slightly moistened with cleaning fluid or alcohol.

- You can also clean the heads by playing a cleaning tape once.

Demagnetizing the heads

- Use a demagnetizing tape available at your dealer.

Specifications**AMPLIFIER**

Output power	2 x 50 W FTC ⁽¹⁾
Signal-to-noise ratio	≥ 75 dBA (IEC)
Frequency response	40 – 20000 Hz, ± 3 dB
Input sensitivity	
AUX/CDR In	500 mV
Output	
Speakers	≥ 6 Ω
Headphones	32 Ω – 1000 Ω
Subwoofer Out	1.5 V ± 2dB, > 22000 Ω
Line Out	500 mV ± 2dB, > 22000 Ω
Digital Out	IEC 958, 44.1 kHz

(1) (6 Ω, 60 Hz – 12.5 kHz, 10% THD)

CD PLAYER

Number of programmable tracks	40
Frequency response	40 – 20000 Hz
Signal-to-noise ratio	≥ 76 dBA
Channel separation	≥ 79 dB (1 kHz)
Total harmonic distortion	< 0.02% (1 kHz)

TUNER

FM wave range	87.5 – 108 MHz
AM wave range	530 – 1700 kHz
Number of presets	40
Antenna	
FM	300 Ω dipole wire
AM	Loop antenna

TAPE DECK

Frequency response	
CrO ₂ tape (type II)	60 – 15000 Hz (5 dB)
Normal tape (type I)	60 – 15000 Hz (5 dB)
Signal-to-noise ratio	
CrO ₂ tape (type II)	≥ 50 dBA
Normal tape (type I)	≥ 47 dBA
Wow and flutter	≤ 0.4% DIN

SPEAKERS

System	3-way; bass reflex
Impedance	6 Ω
Woofer	1 x 5.25"
Tweeter	1 x 2.5"
Polydome Tweeter	2 x 1"
Dimensions (w x h x d)	240 x 395 x 285 mm
Weight	5.5 kg each

CD RECORDER

Frequency response	2 Hz – 22050 Hz
Playback S/N (A-weighted)	100 dB
Playback S/N	100 dB
Playback dynamic range CDR	95 dB
Playback total harmonic distortion CDR ...	91 dB = 0.0033%
Channel separation	100 dB
Recording S/N (A-weighted)	98 dB
Recording S/N digital without SRC	equal to source
Recording dynamic range	92 dB
Recording total harmonic distortion + noise	85 dB
Power Consumption	
Active	15 W
Standby	6 W
Dimensions (w x h x d)	264 x 86 x 305 mm
Weight	4 kg

GENERAL INFORMATION

Material/finish	Polystyrene/Metal
AC Power	120 V / 60 Hz
Power Consumption	
Active	75 W
Standby	< 15 W
Dimensions (w x h x d)	265 x 310 x 363 mm
Weight (without speakers)	7.2 kg

Subject to modification

Warning! Under no circumstances you should try to repair the set yourself as this will invalidate the guarantee. Do not open the set as there is a risk of electric shock.

- If a fault occurs, check the points listed below before taking the system for repair.
- Should any problems persist after you have made these checks, consult your nearest dealer or service center.

CD Player Operation

"NO DISC" is displayed.

- The disc is inserted upside down.
→ *Place CD with printed side up.*
- Moisture condensation at the lens.
→ *Wait until lens has adjusted to normal room temperature.*
- There is no disc in the CD tray.
→ *Insert a CD.*
- The CD is dirty, badly scratched or warped.
→ *Clean or replace the CD.*
- The CD lens is dirty or dusty.
→ *See section under Maintenance.*

"DISC NOT FINALIZED" is displayed.

- The CD-RW or CD-R disc is not properly recorder for the use of a standard CD player.
→ *Read the instruction booklet of your CD-Rewritable or CD-Recorder on how to finalize a recording.*

- The CD is badly scratched or dirty.
→ *Replace or clean CD.*

Radio Reception

Poor radio reception.

- The signal is too weak.
→ *Adjust the antenna.*
- *Connect an external antenna for better reception.*
- The TV or VCR is too close to the stereo system.
→ *Separate the stereo system from the TV or VCR.*

Tape Deck Operation

Recording or playback cannot occur or there is a decrease in audio level.

- Dirty tape heads, capstans or pressure rollers.
→ *See section on tape deck maintenance.*
- Magnetic build-up in the record/playback head.
→ *Use demagnetizing tape.*

General

System does not react when any button is pressed.

- Electrostatic discharge.
→ *Press STANDBY-ON to switch the system off. Remove the AC power plug from the wall outlet, then reconnect the power plug and switch on the system again.*

No or poor sound.

- Volume is not turned up.
→ *Adjust VOLUME.*
- The headphones are connected.
→ *Disconnect the headphones.*
- Speakers are not connected or are connected wrongly.
→ *Check that the speakers are connected correctly.*
- *Make sure the stripped speaker wire is clamped.*

Reversed left and right sound.

- Speakers are connected wrongly.
→ *Check the speaker connections and location.*

Lack of bass sound or apparently imprecise physical location of musical instruments.

- Speakers are connected wrongly.
→ *Check the speaker connection for proper phasing, colored/black wires to colored/black terminals.*

Remote control has no effect on the system.

- Wrong source is selected.
→ *Select the source (CD, TUNER, etc.) before pressing the function button, (▶, ◀, ▶, etc.).*
- The distance to the system is too large.
→ *Reduce the distance.*
- Batteries are inserted incorrectly.
→ *Insert the batteries with their polarities (+/- signs) as indicated.*

- Batteries are exhausted.
→ *Replace the batteries.*

Timer not working.

- Clock is not set.
→ *Set the clock.*
- Timer is not switched on.
→ *Press CLOCK/TIMER to switch on the timer.*
- Recording is in progress.
→ *Stop recording.*

Clock setting is erased.

- There was a power failure.
→ *Reset the clock.*

System displays features automatically; buttons flash continuously.

- Demonstration mode is switched on.
→ *Press and hold ■ (on the system only) for five seconds to switch off the demonstration.*

A howling sound at external source.

- You hear feedback when you are listening and recording from the same source simultaneously.
→ *Press AUX to select CDR mode.*

All lighted buttons are not lit.

- Equalizer Display is switched on in NITE mode.
→ *Rotate JOG to other Equalizer Display.*

CD Recorder

System does not react.

- CD Recorder is in standby mode.
 - Press any key to activate the CD Recorder.
- The system is not switched on.
 - Ensure that the ON/OFF button is on.
- Main cable is not connected.
 - Ensure that the mains cable is plugged in correctly.
- Player does not react.
 - Switch the ON/OFF button on the front of the player OFF and back ON.

No sound.

- The audio equipments are not connected or are connected wrongly.
 - Check the audio connections.
 - if using an amplifier, try using a different source.

Amplifier sound is distorted.

- CD Recorder analog output connection to amplifier is not correct.
 - Check that the CD recorder analog output is not connected to the amplifier Phono input

Playback will not start.

- The disc is not inserted properly.
 - Ensure that the label of the CD is facing up.
- The disc is dirty or dusty.
 - Clean the disc.
- The disc is defective.
 - Check that the disc is not defective by trying another disc.

Cannot record.

- The disc is dirty or dusty.
 - Clean the disc.
- Check if CDR(W) is an finalized disc.
 - Unfinalized the disc.

"WRONG DISC" is displayed.

- The disc is not an AUDIO disc,
 - Replace the disc.

"CHECK INPUT" is displayed.

- Wrong input source chosen.
 - Reselect the correct source.

"MEMORY FULL/FINALIZE CD" is displayed.

- CDRW has to be unfinalized for recording.
 - Erase text or finalize disc to obtain memory space.

Recording is distorted.

- Recording level is not correct.
 - Make sure the recording level is correct.

"DISC RECOVER" on display.

- Power failure has occurred during recording
 - Wait for the CD recorder to repair the disc.